

Product data sheet

M8 PCB Panel Mount



<https://www.finecables.com/m8-pcb-panel-mount-a-coded/168/>

Product description	M8 Female A-coding Angled Connector, PCB Panel Mount, Front fastened, Contacts: 4, Shielded, IP67, UL Listed: CYJV(CYJV7).E321413
Part no.	MB08FBSAFF04RA

Illustration



Scale drawing

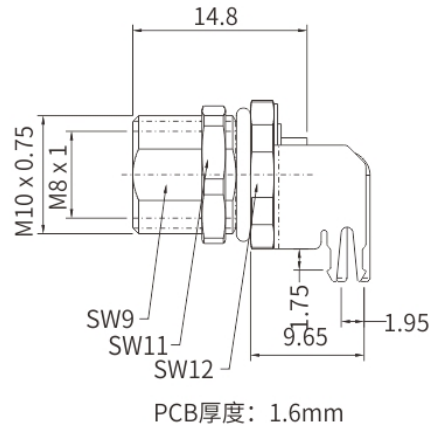

You can find the assembly instructions on the next page.

General features

Part no.	MB08FBSAFF04RA
Standard	IEC 61076-2-104
Ambient temperature	-25°C ~ +90°C
IP rating	IP67 in locked condition
Mating endurance	>500 cycles

Electrical parameters

Insulation resistance	≥100MΩ
Contact resistance	≤5mΩ
Shielding	Available
Rated current	3A
Rated voltage	50V AC / 60V DC

Material

Connector insert	TPU; PA+GF
Connector contacts	Brass with gold plated
Coupling nut/screw	Brass with nickel plated
Seal/O-ring	Epoxy resin / FKM

Security Notices

The connector must not be plugged or unplugged under load. Non-observance and improper use can

Product data sheet
M8 PCB Panel Mount



<https://www.finecables.com/m8-pcb-panel-mount-a-coded/168/>

Product description	M8 Female A-coding Angled Connector, PCB Panel Mount, Front fastened, Contacts: 4, Shielded, IP67, UL Listed: CYJV(CYJV7).E321413
Part no.	MB08FBSAFF04RA

result in personal injury.

The connectors have been developed for applications in plant engineering, control and electrical equipment construction. The user is responsible for checking whether the connectors can also be used in other areas of application.

Connectors which are used in circuits with voltages dangerous to the touch may only be installed and used by, or under the supervision of, persons with electrical engineering training, taking into account the applicable regulations and standards.

The user must take suitable safety precautions to ensure that the connector cannot be accidentally disconnected.

Please observe the pollution degree and the overvoltage category. For further information, please refer to the download center "Technical Information".

Finecables Enterprise Co., Ltd

Email: info@finecables.com

Web: www.finecables.com

Tel: +86 0769-81517898

Address: No.54 Changdi Road, Nanmian Community Humen Town Dongguan City, Guangdong Province, China.