

# Product data sheet

## M8 Field Wirable Assembly



Product description	M8 Male A-coding Straight Connector, Screw Field Wirable Assembly, Contacts: 3, Unshielded, IP68
Part no.	MB08MWAFF03ST

### Illustration



### Scale drawing

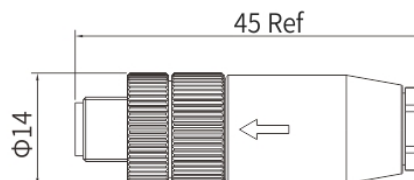

You can find the assembly instructions on the next page.

### General features

Part no.	<b>MB08MWAFF03ST</b>
Standard	IEC 61076-2-104
Ambient temperature	-40°C ~ +90°C
Suitable Cable Dia	3.5~4.5mm
IP rating	IP68 in locked condition
Mating endurance	>500 cycles

### Electrical parameters

Insulation resistance	$\geq 100\text{M}\Omega$
Contact resistance	$\leq 5\text{m}\Omega$
Shielding	Unavailable
Rated current	3A
Rated voltage	60V AC / DC
Wire gauge	0.25mm <sup>2</sup> (AWG24)

### Material

Connector insert	PA+GF
Connector contacts	Brass with gold plated
Coupling nut/screw	Brass with nickel plated
Connector body	PA+GF

# Product data sheet

## M8 Field Wirable Assembly



Product description	M8 Male A-coding Straight Connector, Screw Field Wirable Assembly, Contacts: 3, Unshielded, IP68
Part no.	MB08MWAFF03ST

Seal/O-ring FKM

### Assembly instructions

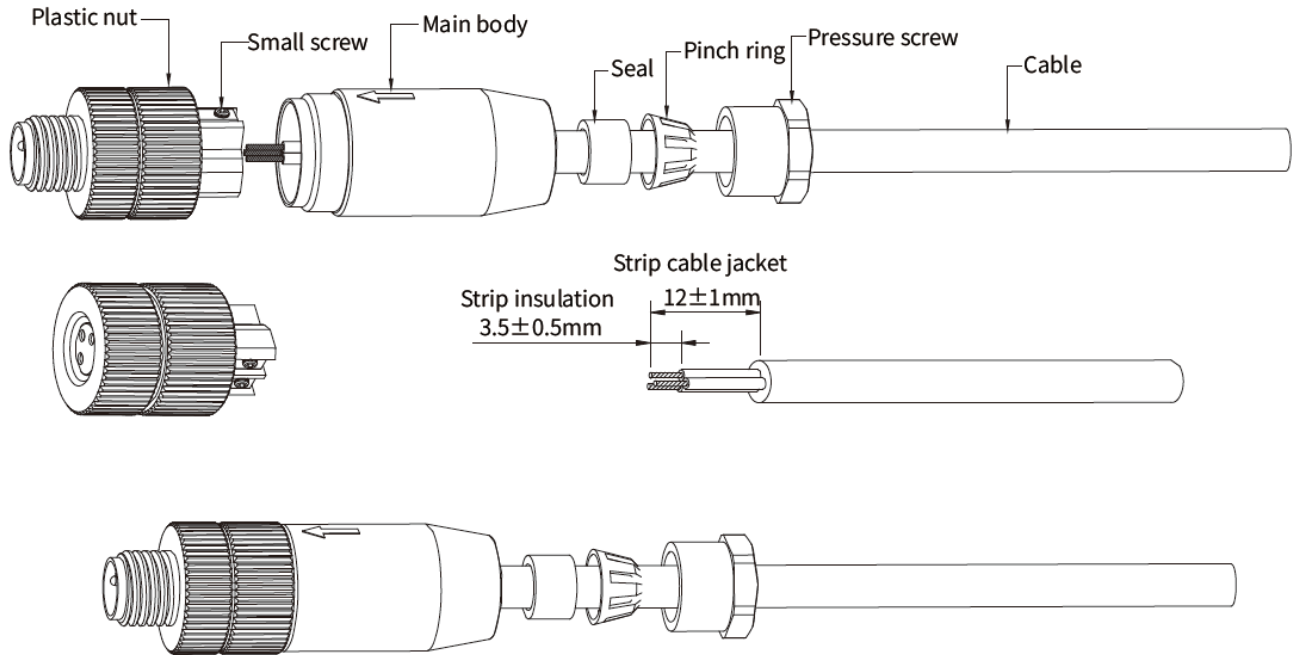

### Security Notices

The connector must not be plugged or unplugged under load. Non-observance and improper use can result in personal injury.

The connectors have been developed for applications in plant engineering, control and electrical equipment construction. The user is responsible for checking whether the connectors can also be used in other areas of application.

Connectors which are used in circuits with voltages dangerous to the touch may only be installed and used by, or under the supervision of, persons with electrical engineering training, taking into account the applicable regulations and standards.

The user must take suitable safety precautions to ensure that the connector cannot be accidentally disconnected.

Please observe the pollution degree and the overvoltage category. For further information, please refer to the download center "Technical Information".

Finecables Enterprise Co., Ltd

Email: [info@finecables.com](mailto:info@finecables.com)

**Product data sheet**  
**M8 Field Wirable Assembly**



Product description	M8 Male A-coding Straight Connector, Screw Field Wirable Assembly, Contacts: 3, Unshielded, IP68
Part no.	MB08MWAFF03ST

Web: [www.finecables.com](http://www.finecables.com)

Tel: +86 0769-81517898

Address: No.54 Changdi Road, Nanmian Community Humen Town Dongguan City, Guangdong Province, China.



## DECLARATION FROM THE MANUFACTURER

For part no.: MB08MWAFF03ST

25/06/2026

With regard to the

**Regulation (EC) No 1907/2006 of the European Parliament and of the Council of 18 December 2006 concerning the Registration, Evaluation, Authorisation and Restriction of Chemicals (REACH), establishing a European Chemicals Agency, amending Directive 1999/45/EC and repealing Council Regulation (EEC) No 793/93 and Commission Regulation (EC) No 1488/94 as well as Council Directive 76/769/EEC and Commission Directives 91/155/EEC, 93/67/EEC, 93/105/EC and 2000/21/EC.**

With the REACH regulation, the EU has created a uniform system for the Registration, Evaluation, Authorisation and restriction of Chemicals - or REACH. The purpose of this regulation is to ensure a high level of protection of human health and the environment.

Franz Binder GmbH & Co. Elektrische Bauelemente KG hereby confirms that it acts as a downstream user (producer of products) according to the aforementioned regulation.

We obtain all raw materials and/or preparations, from which the connectors are made, from suppliers who have already registered or pre-registered all substances, including those present in the preparations. The products supplied by the company are not subject to registration.

With regard to Article 33(1) of the REACH regulation, Franz Binder GmbH & Co. Elektrische Bauelemente KG complies with its information obligations:

An up-to-date candidate list (candidate list of substances of very high concern for authorisation, as of 25/06/2025 see: <https://echa.europa.eu/de/candidate-list-table>) in accordance with Article 59 (1, 10) of the regulation (EC) No 1907/2006 (REACH) has been published.

The aforementioned article includes the following substances from the up-to-date candidate list in concentrations of more than 0,1 percent by mass:

CAS 7439-92-1 (Lead)

Please refer any questions to our Product Compliance Team:

[info@finecables.com](mailto:info@finecables.com)

25/06/2026





## **DECLARATION FROM THE MANUFACTURER**

**For part no.: MB08MWAFF03ST**

**25/06/2026**

**With regard to the**

**COMMISSION DELEGATED DIRECTIVE (EU) 2015/863**

**of 31 March 2015**

**amending Annex II to Directive 2011/65/EU of the European Parliament and of the Council as regards the list of restricted substances**

Directive 2011/65/EU stipulates provisions on the restriction of the use of hazardous substances in electrical and electronic equipment (EEE) with a view to contributing to the protection of human health and the environment, including the environmentally sound recovery and disposal of EEE waste.

### **ANNEX II**

Restricted substances referred to in Article 4(1) and maximum concentration values tolerated by weight in homogeneous materials

Lead (0,1%) mercury (0,1%) cadmium (0,01%) hexavalent chromium (0,1%) polybrominated biphenyls (PBB) (0,1%) polybrominated diphenyl ethers (PBDE) (0,1%) bis(2-ethylhexyl) phthalate (DEHP) (0,1%) butyl benzyl phthalate (BBP) (0,1%) dibutyl phthalate (DBP) (0,1%) diisobutyl phthalate (DIBP) (0,1%)

Franz Binder GmbH & Co. Elektrische Bauelemente KG hereby confirms that it complies with all standard articles of the aforementioned Directive. Our products do not contain any of the specified prohibited substances above the maximum permitted concentrations specified therein, taking into account the exemptions in Annex III of Directive 2011/65/EU.

Complies with RoHS III with exemption 6c

Please refer any questions to our Product Compliance Team:

[info@finecables.com](mailto:info@finecables.com)

25/06/2026



## MANUFACTURER'S DECLARATION

For part no.: MB08MWAFF03ST

25/06/2026

With regard to the

### Declaration of compliance with China RoHS - Components

We herewith declare the compliance of this product with the Chinese marking requirements. This product can be recycled and used safely during its environmentally friendly use period of 50 years. These articles will be sold as components only for manufacturing. According to the Electronic Industry Standard SJ/T 11364-2014 it needs not to be marked with Environmentally Friendly Use Period (EFUP) label. This product should be recycled after its environmental protection use period has expired because it may contain substances or elements as shown in the following table:

Part Name	Hazardous Substance					
	Lead (Pb)	Mercury (Hg)	Cadmium (Cd)	Hexavalent Chromium (Cr(VI))	Polybrominated biphenyls (PBB)	Polybrominated diphenyl ethers (PBDE)
Connectors	X	O	O	O	O	O

This table is prepared in accordance with the provisions of SJ/T 11364.

O: Indicates that said hazardous substance contained in all of the homogeneous materials for this part is below the limit requirement of GB/T 26572

X: Indicates that said hazardous substance contained in at least one of the homogeneous materials used for this part is above the limit requirement of GB/T 26572

The table shows where these substances may be found in this Electrical and Electronic Product.

Please refer any questions to our Product Compliance Team:

info@finecables.com

25/06/2026

